

# SPECIFICATION DRASH シリーズ別 大きさ比較

寸法は全て外寸です

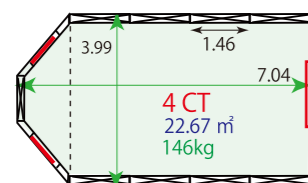

## C シリーズ

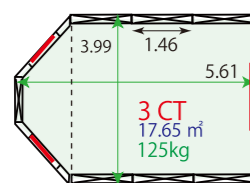
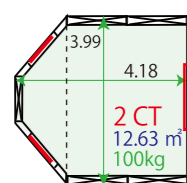
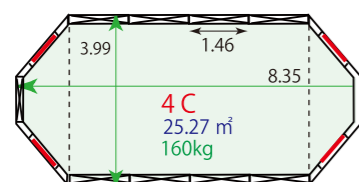
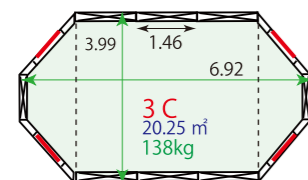
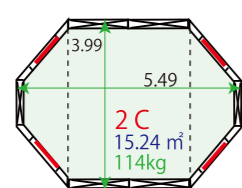
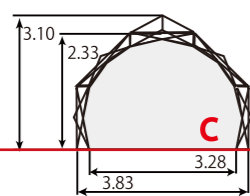

## XB シリーズ

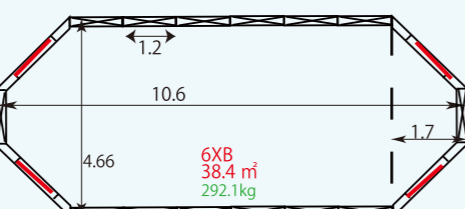
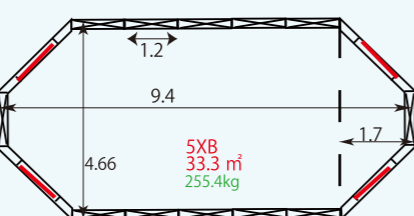
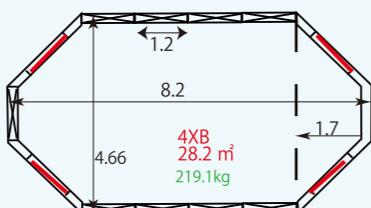
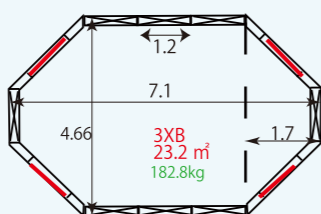
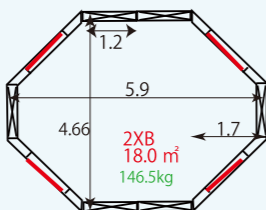
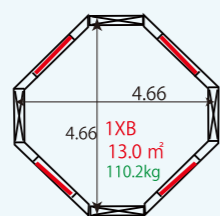
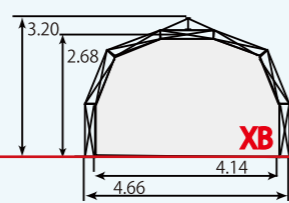

## XBT シリーズ

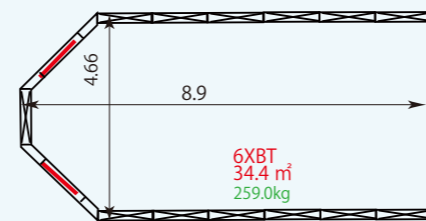
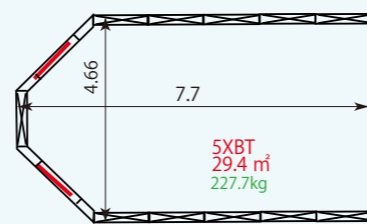
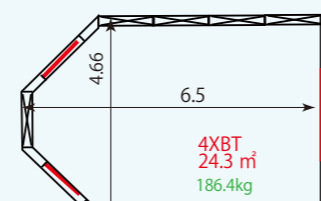
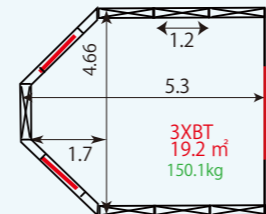
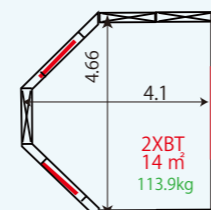
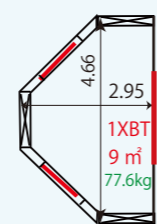

## M シリーズ

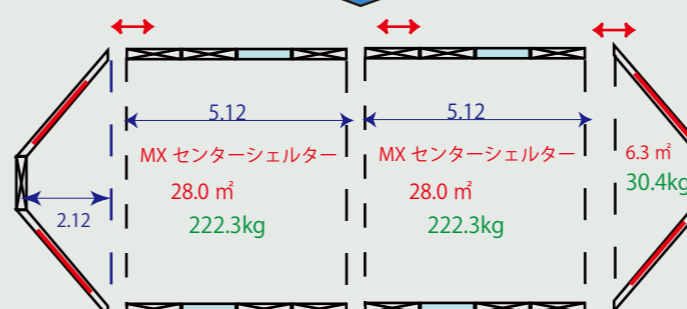
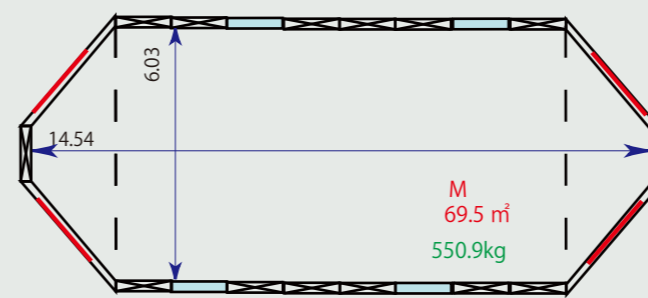
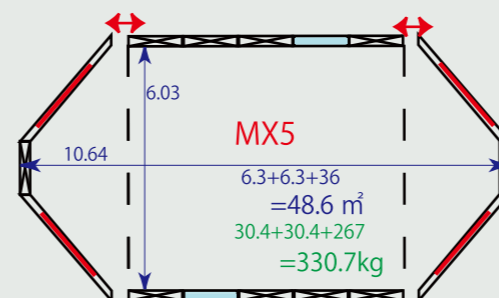
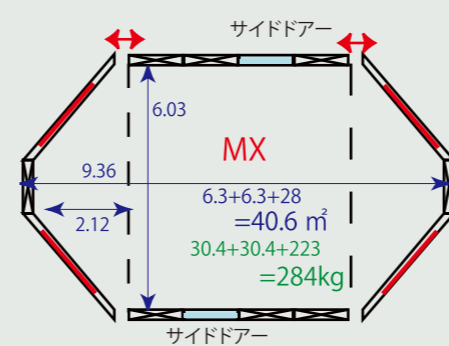
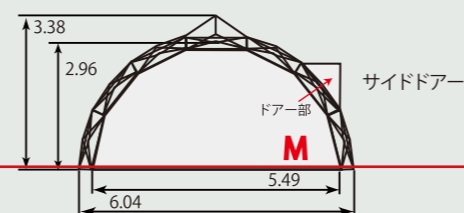

MX用  
入口シェルター

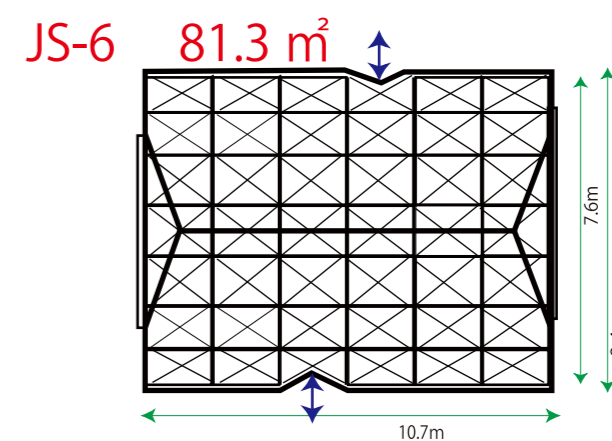
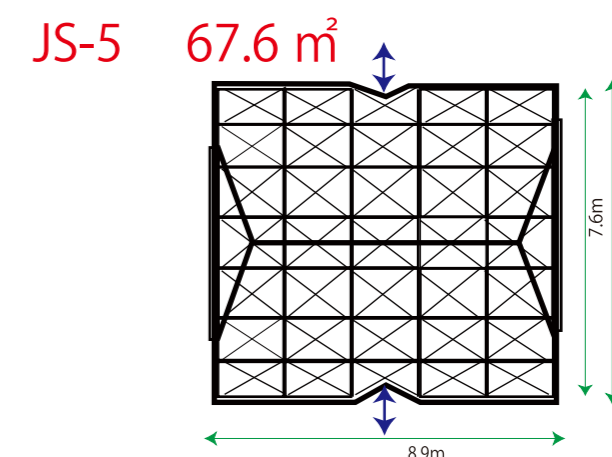
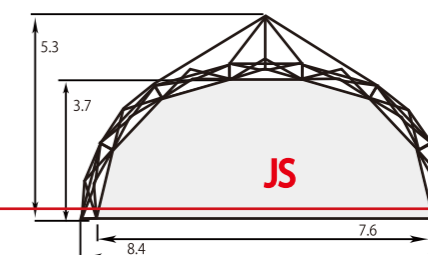

J Shelter 98+9+9  
=116 m²

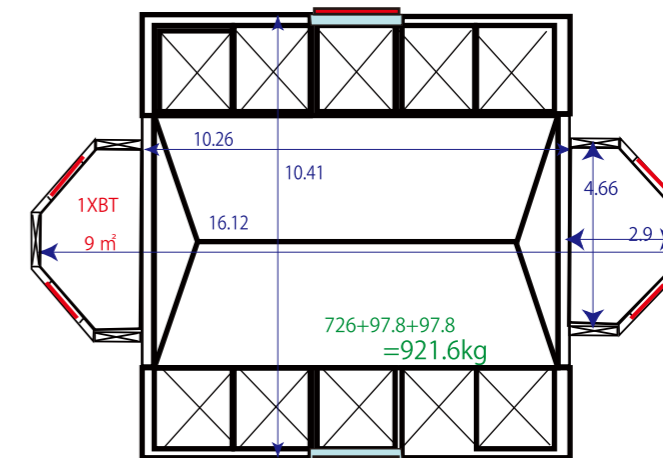

DHS SYSTEMS LLC  
A DHS TECHNOLOGIES COMPANY

1st RESPONDER

1st Receiver

2nd RESPONDER

2nd Receiver

一覧

解体新書

電源装置と空間システム

サポート・オプション品